

Edge A system

600x600, 1200x600,
625x625, 1250x625
(Not valid for Combison)

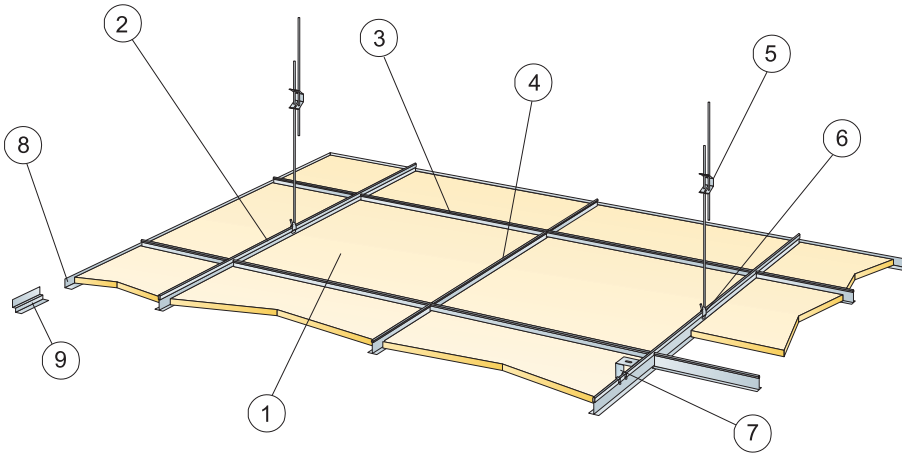
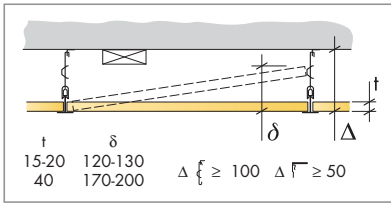

1. Ecophon Edge A panel 600x600/1200x600
625x625/1250x625

2. Connect T24 or T15 Main runner

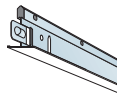

3. Connect T24 or T15 Cross tee,
L=1200/1250

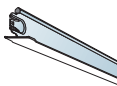

4. Connect T24 or T15 Cross tee,
L=600/625

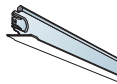

5. Connect Adjustable hanger



6. Connect Hanger clip



7. Connect Direct fixing bracket



8. Connect Angle trim

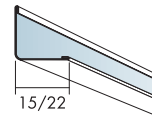

9. Connect Shadow-line trim

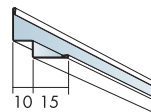

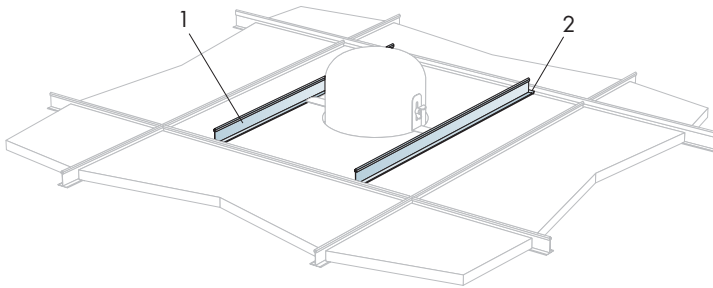

→ 12

1. Connect Bridging profile

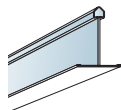

2. Connect Bridging clip 5/20



Ecophon[®]
SAINT-GOBAIN

A SOUND EFFECT ON PEOPLE

www.ecophon.com

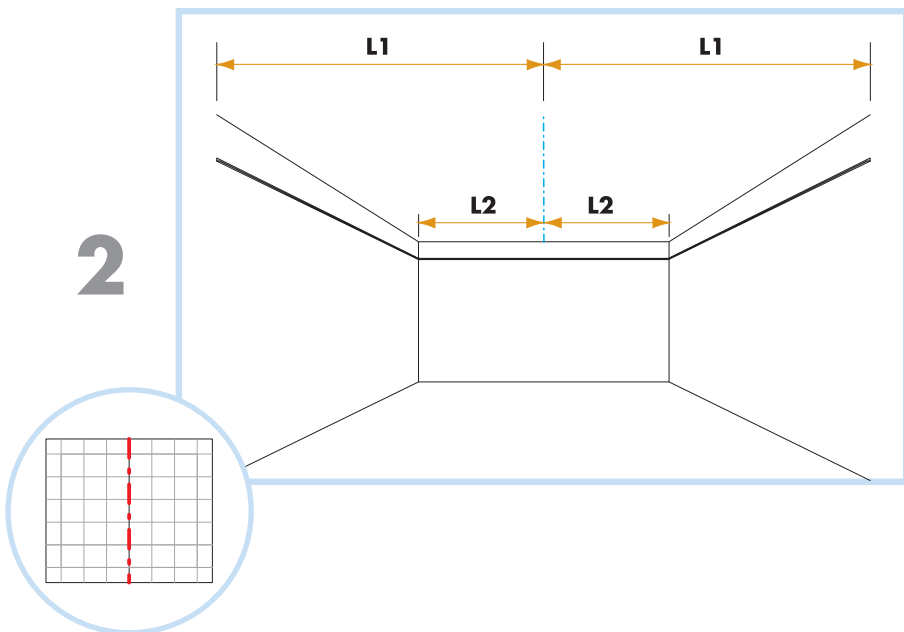
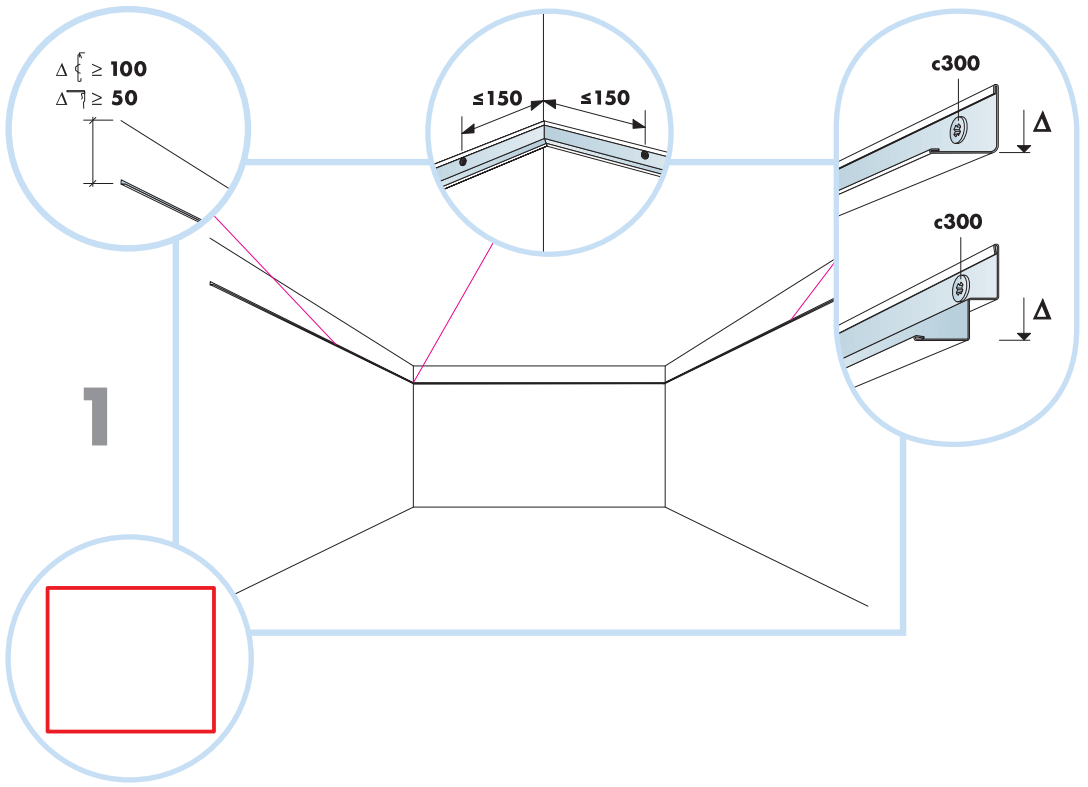

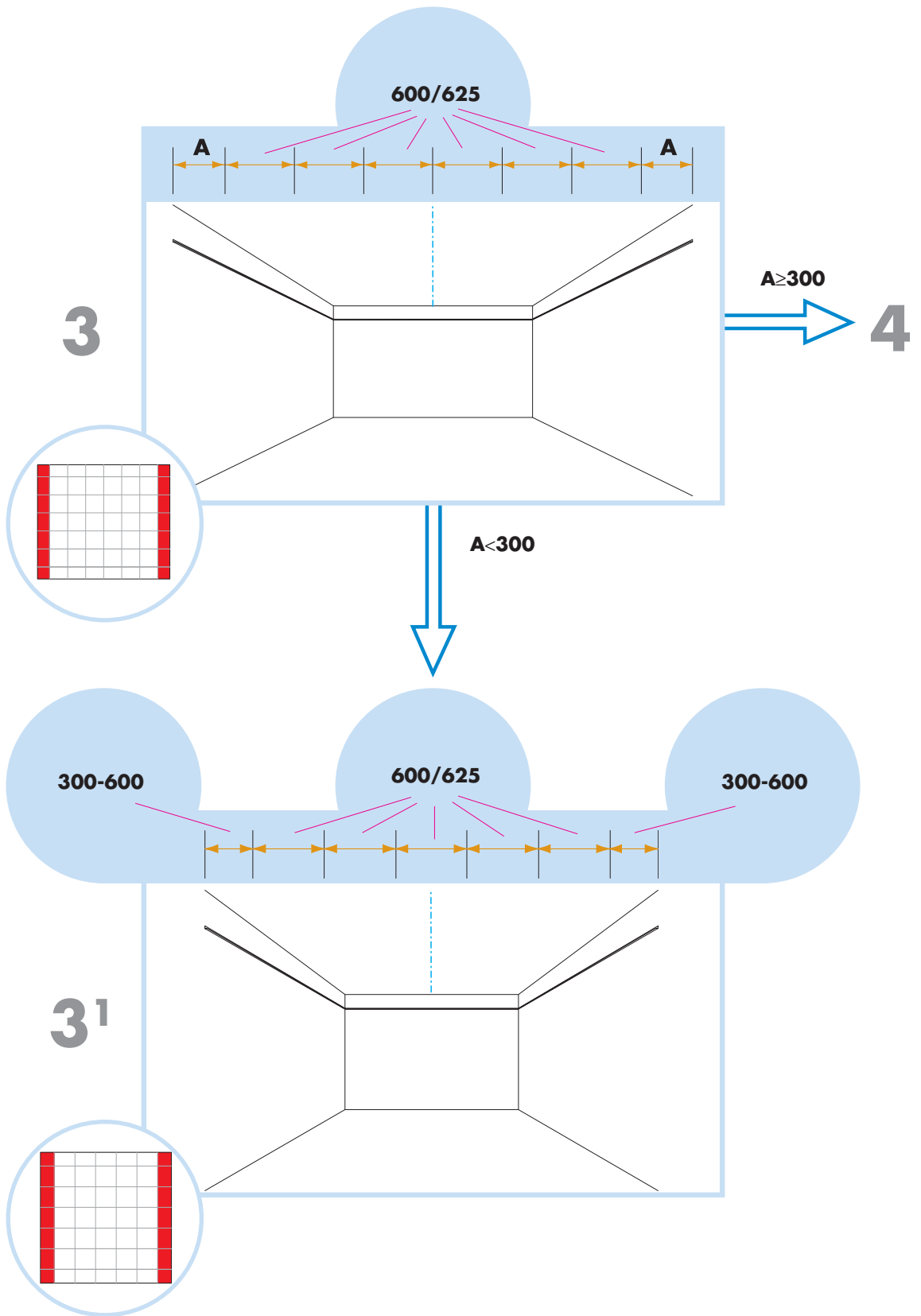

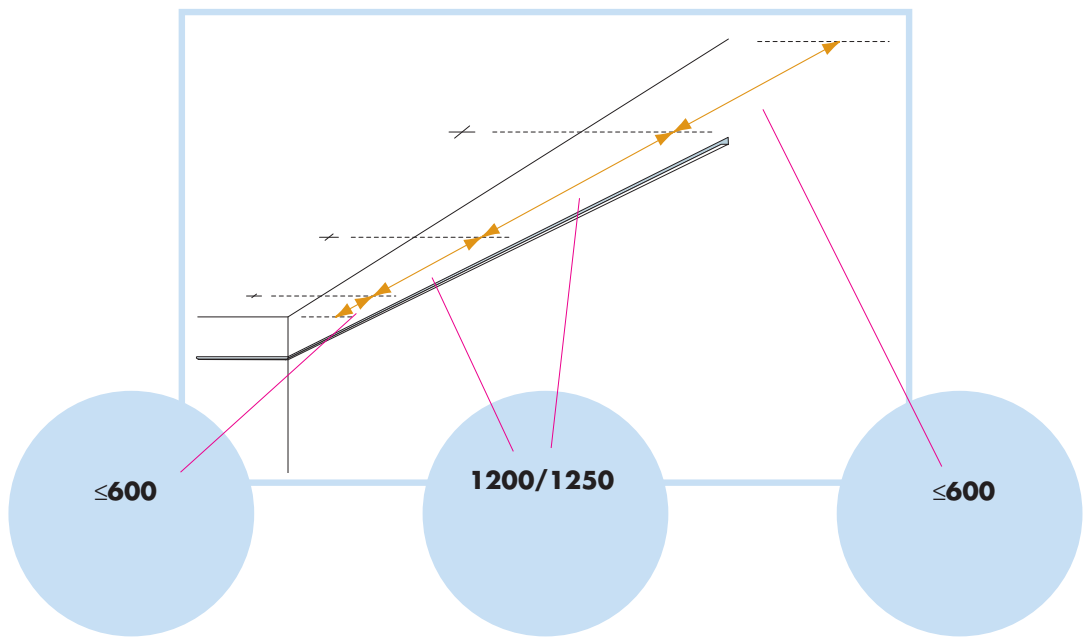
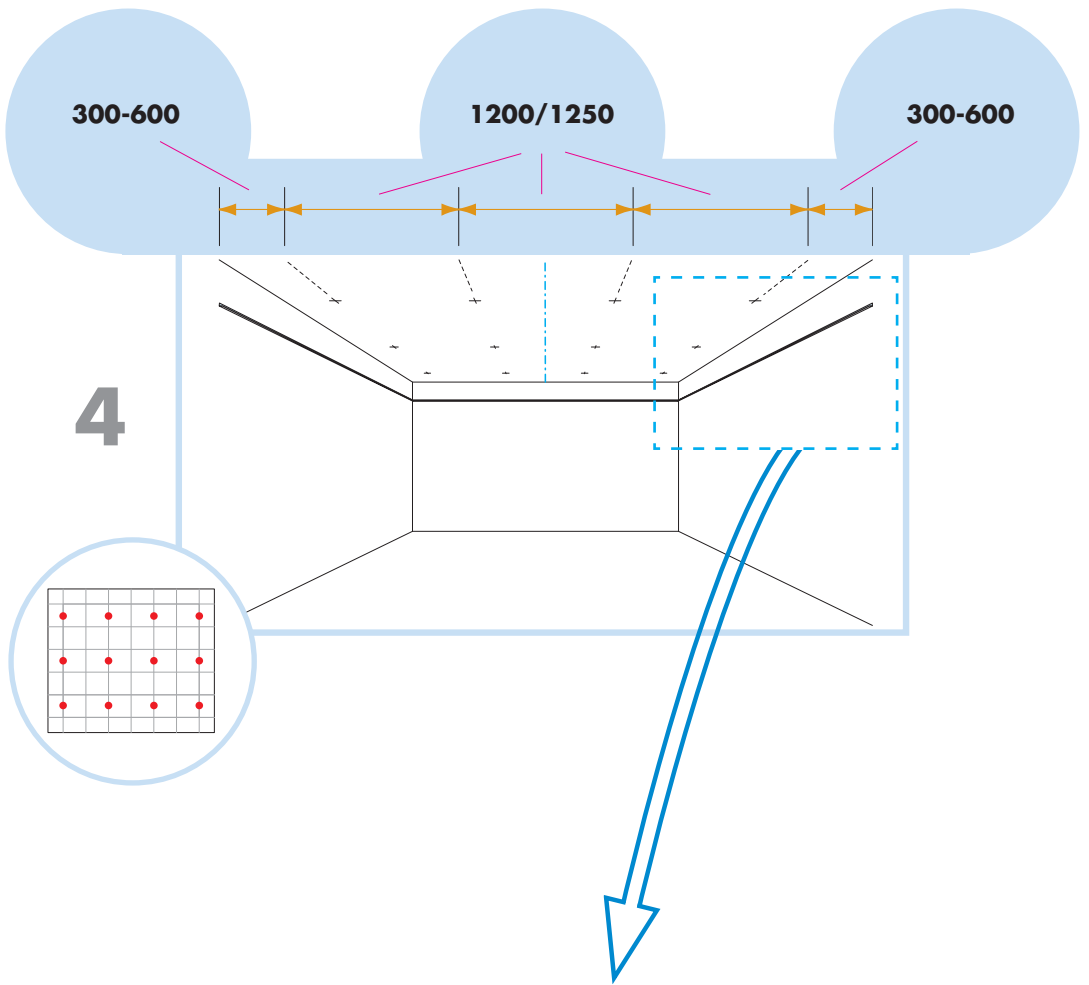

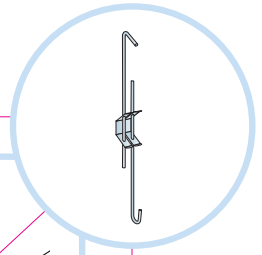
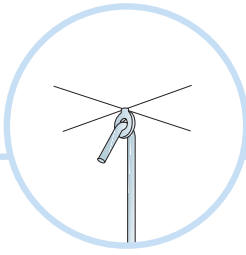
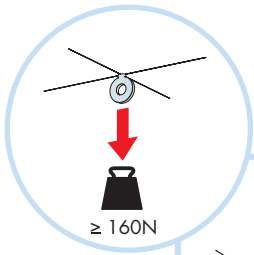

5

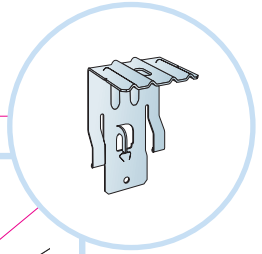
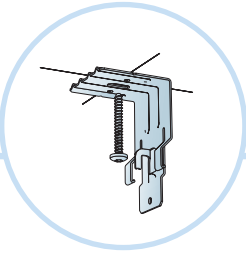
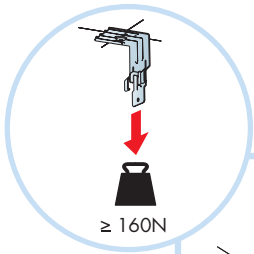
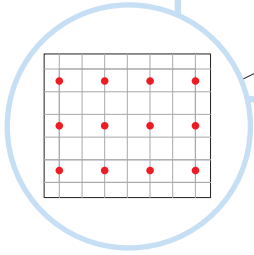
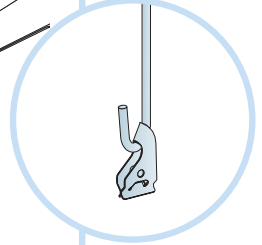
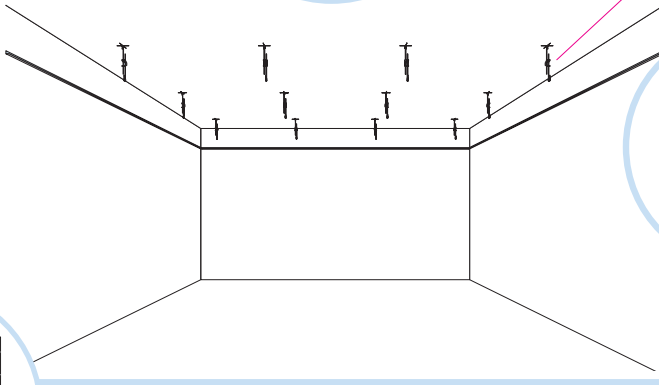

5₁

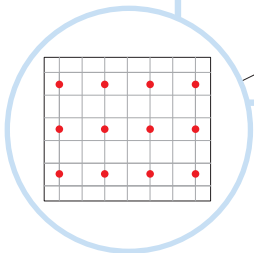
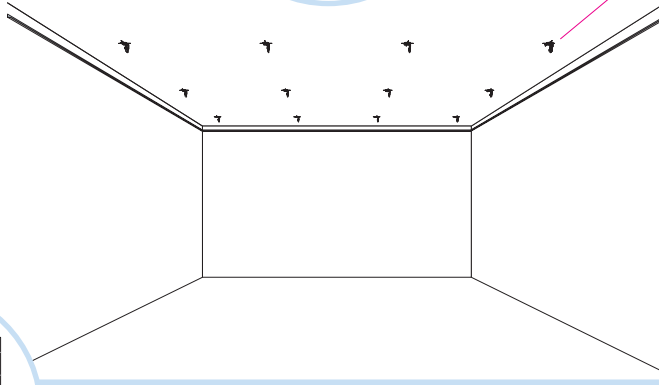

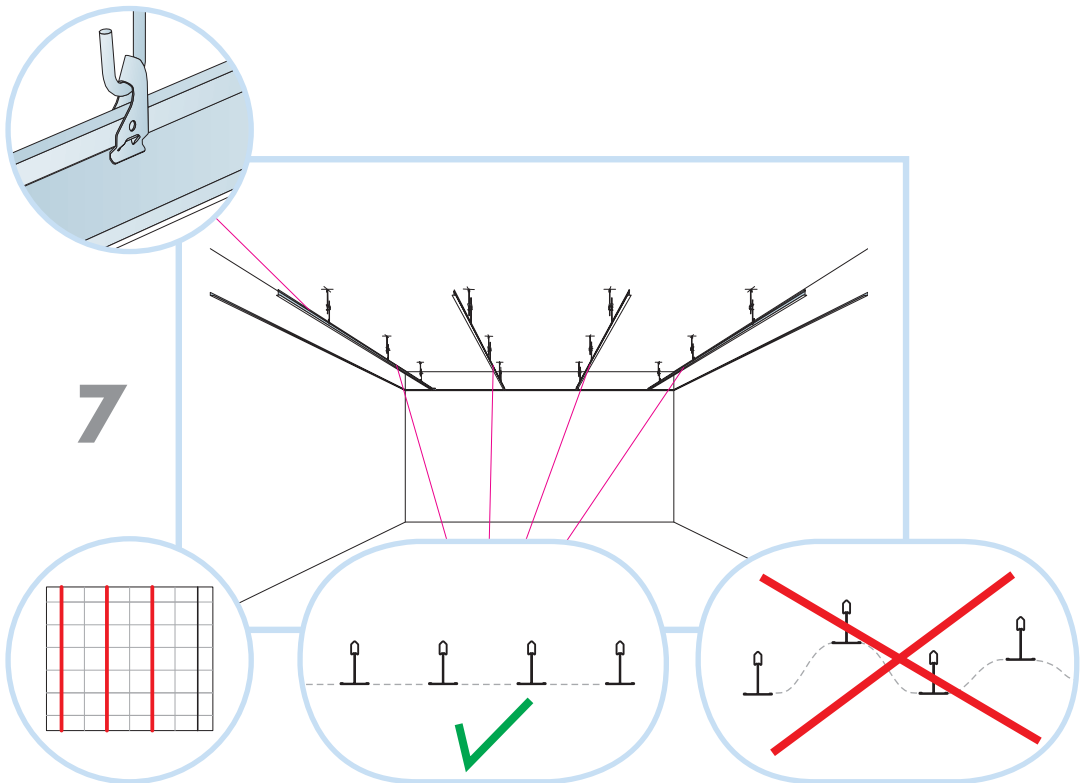
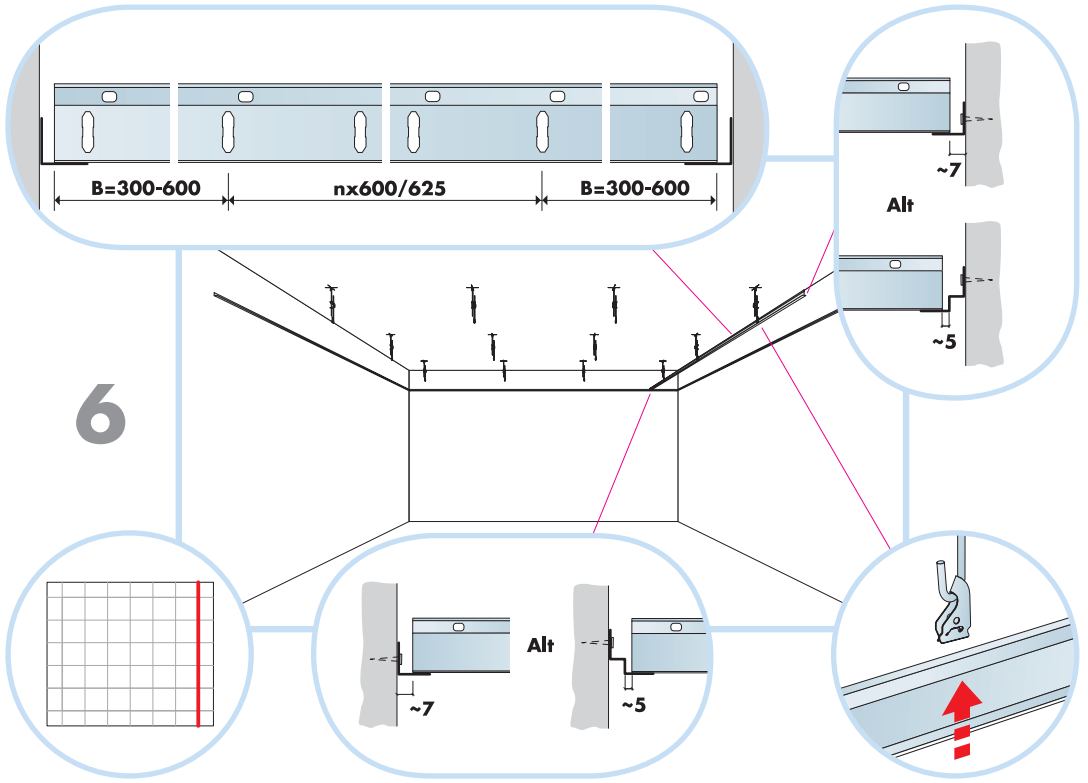

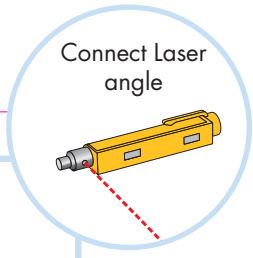
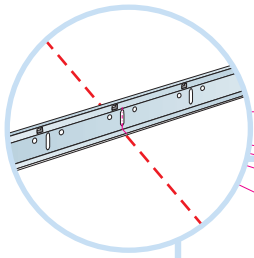

Connect Laser angle

7₁

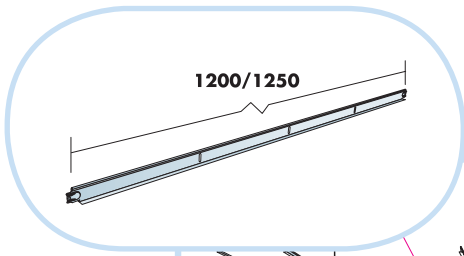
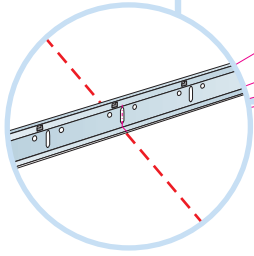
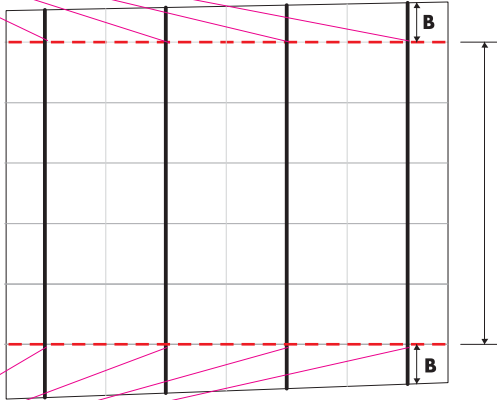

8₁

8

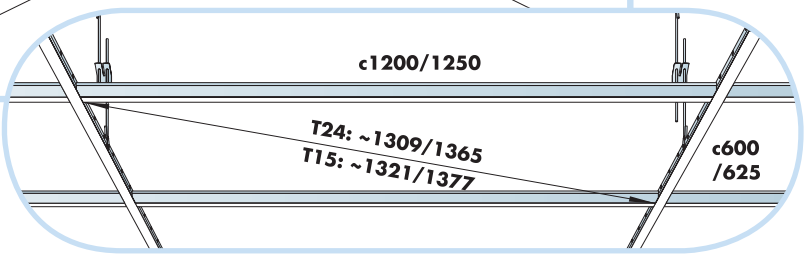
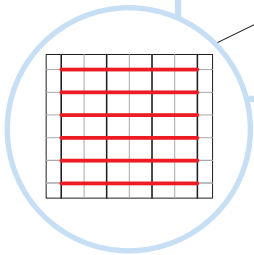
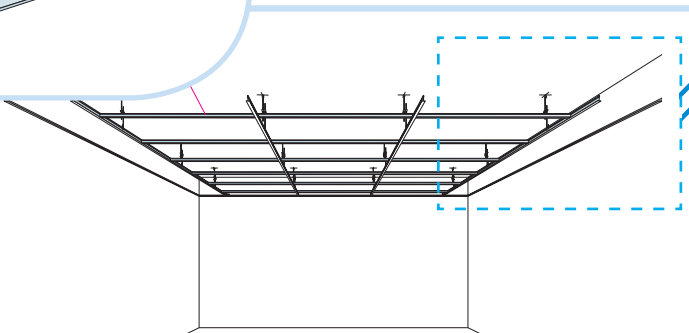

8₁

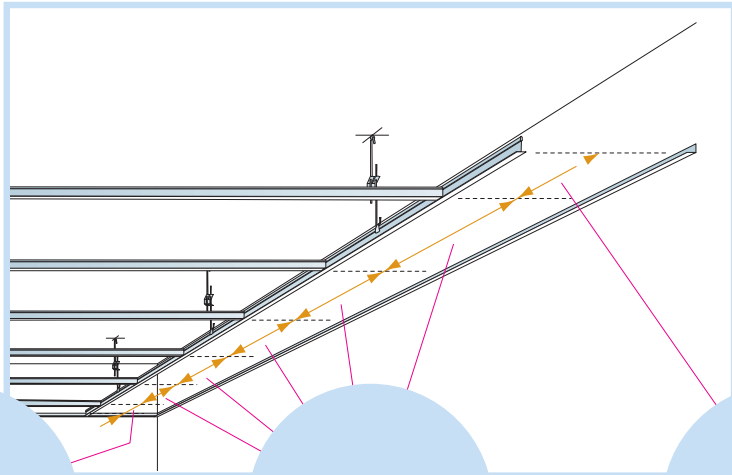

300-600

600/625

300-600

T24

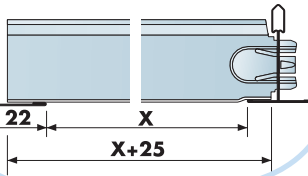

T15

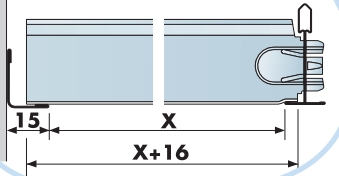

9

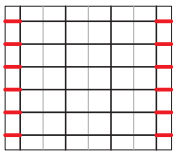
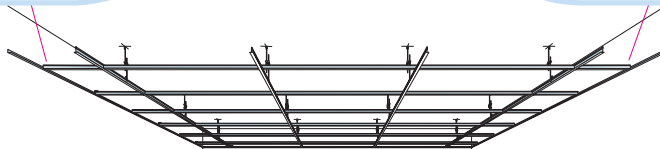

T24/T15

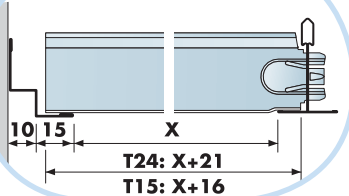

600x600/625x625 → 10
1200x600/1250x625 → 11

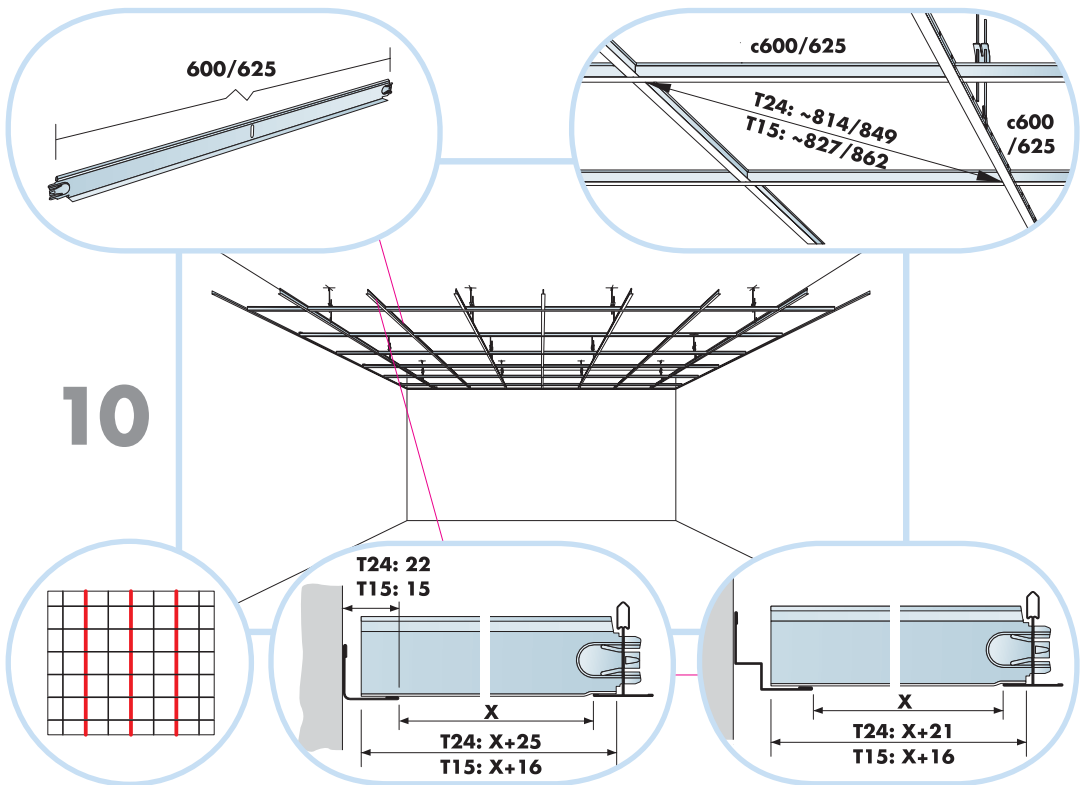

11

A-A alt1

T24

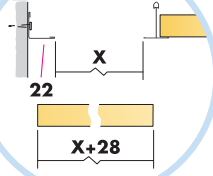

A-A alt2

T15

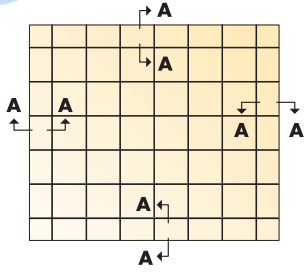
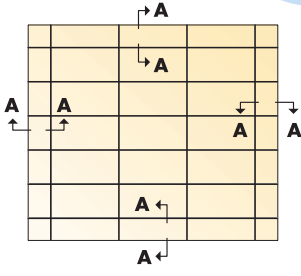
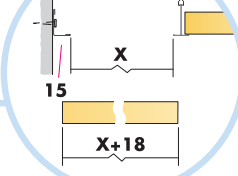

1200x600
1250x625

600x600
625x625

T24

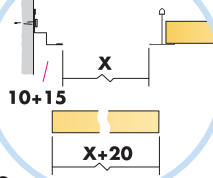

T15

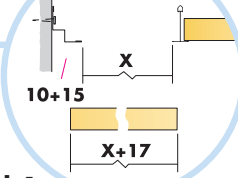

A-A alt3

A-A alt4

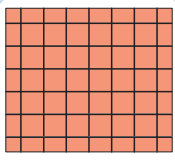

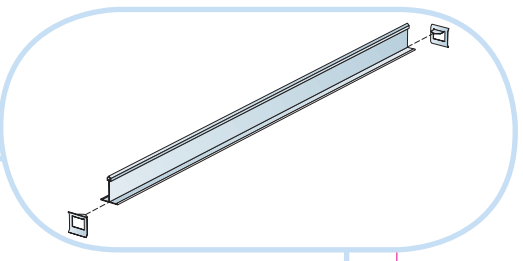
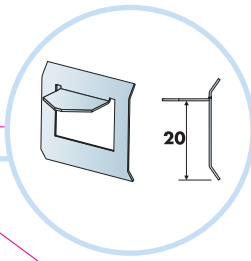
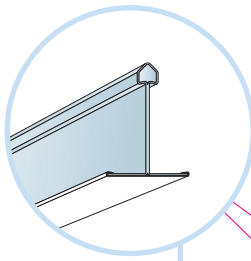

12

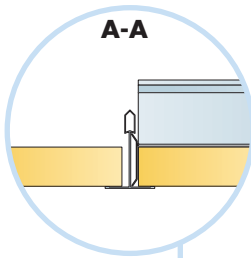
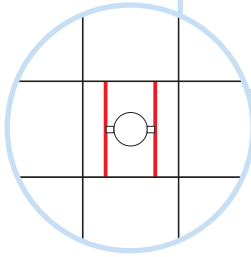
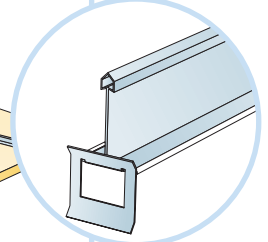
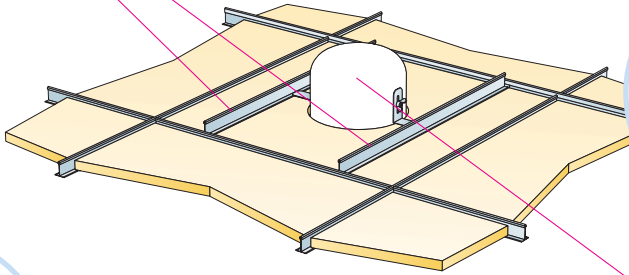

Alt 1

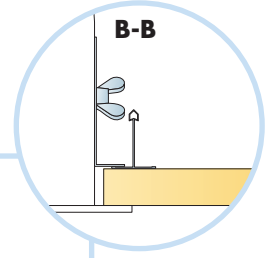

13

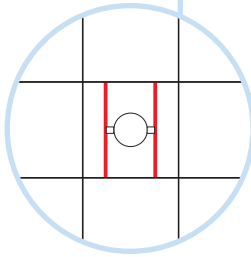
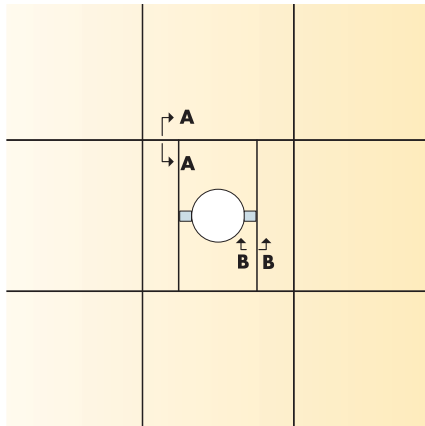

Alt 2

A-A

B-B

C-C

14

A
A
Bt ↑ B

Ct ↑ C

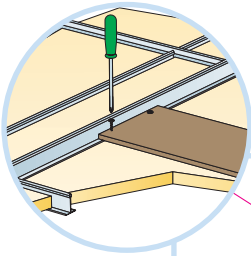
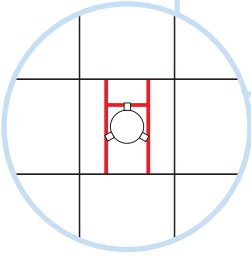

Alt 3

15

